

12x24x8 Instant Shelter INSTRUCTION MANUAL

#193 – 4878

Parts Alert!

If you have a question or if there are missing parts, please call:

Email Service@shelterit.com

Or call **203-591-9032**

Monday-Friday 9:00am-5:00 p.m. EST

Missing parts will be sent to you via courier.

Visit ShelterIt.com for instructional video

DO NOT RETURN TO STORE!

Please read instructions fully before beginning assembly!

V.4.

TABLE OF CONTENTS

SAFETY CAUTIONS.....	3-4
PARTS LIST.....	4-6
ASSEMBLY INSTRUCTIONS.....	6-13
PARTS SCHEMATIC.....	7
LIMITED WARRANTY.....	16

SAFETY and PRE-ASSEMBLY CAUTIONS

READ PRIOR TO ASSEMBLY!

DO NOT ASSEMBLE OR DISASSEMBLE THE STRUCTURE ON A WINDY DAY. ONCE ASSEMBLED, IF HIGH WINDS ARE FORECASTED WE RECOMMEND YOU TO REMOVE THE COVER AND STORE UNTIL THE WINDY CONDITIONS HAVE PASSED.

WARNING!

1. The cover is made of 3-layer polyethylene. Please do not use open flames and heated elements inside or in close proximity to the product (including all types of stoves, gas heaters, gas lanterns, citronella torches, mosquito coils, etc.). The fabric will burn if left in continuous contact with a flame or heat source. Any damage to the cover as a result of using open flames or heating elements will void the Manufacturer's warranty.
2. This is a temporary structure and is not recommended for use as a permanent structure.
3. Choose your shelter's location carefully. Check for overhead utility lines, branches, etc. Do NOT install near roofs or other structures that may shed snow or ice onto the shelter.
4. Inventory all parts before attempting installation.
5. Always wear safety glasses and gloves when assembling or disassembling this product.
6. The shelter must be installed on a level surface.
7. Anchors must be used with all shelters. When erecting shelters, covers should NOT be installed on any product until it has been properly anchored to the ground. Any shelter that is not anchored securely or properly will blow away. Proper anchoring of the shelter and suitable soil conditions are the responsibility of the customer.
8. Never start gas engines from any vehicle or other machinery within a closed shelter. Special ventilation including an open door should be used at all times for these situations. Any work with paints, cleaning products, etc, may require additional ventilation. When possible always avoid working with such chemicals inside the shelter.
9. Do NOT use barbeque grills, smokers or other flammable equipment under or inside any shelter.
10. Do not cook, smoke, use flammable devices, refuel or store flammable materials in this shelter. Never use or ignite an open flame in the shelter. Open flames must be kept a safe distance away from the shelter.
11. No snow accumulation should be allowed on the shelter. Monitor continuously for accumulated snow on the roof. Snow or ice accumulation may cause your shelter to collapse. This shelter is NOT designed to hold heavy snow or ice loads. Brush snow and ice off the roof top with a broom or mop. Failure to remove snow will void the Manufacturer's warranty.
12. Never clear the roof of snow or debris from inside the shelter. Doing so will increase the risk of collapse, damage to property, personal injury and/or death.
13. Municipal by-laws must be verified prior to setting up this temporary shelter.

CARE & CLEANING

1. After assembly, periodically check the anchors, the tension of ratchets, buckles and all hardware to ensure the stability of the shelter. Especially during the first few weeks it will be necessary to tighten the cover and hardware. Always ensure that all covers and hardware are kept tightened.

2. Do NOT apply any "Protect & Shine" type products to the cover or other harsh abrasives including bleach or cleansers. The cover can be easily cleaned with mild soap and water. If storing the cover after cleaning, allow it to fully dry prior to storage.
3. Do NOT use the product for purposes or in an environment for which it is not intended, (e.g. extreme cold, high wind conditions, extreme heat, heavy rainfall, etc.).

Please note that the Manufacturer has no control over the elements such as wind, heavy snow or rain. The Manufacturer cannot control the location or soil conditions into which the shelter is placed. The Manufacturer, without control of the elements, location or soil conditions, cannot be held responsible for damages caused by the shelter to other items or damages to the shelter itself.

ASSEMBLY



Please read instructions fully before beginning assembly.







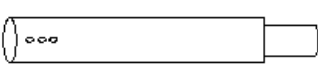
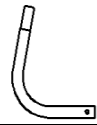

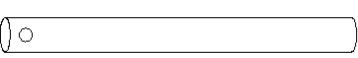
Step 1: Checking the Parts

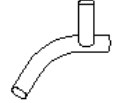
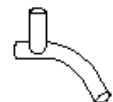
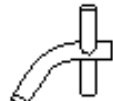
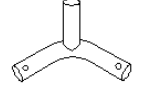
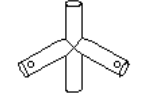
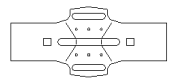
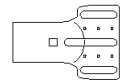
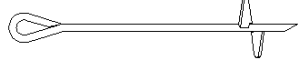

Unpack and check the contents of the box. Make sure that you have all the parts described in the parts list shown hereafter.

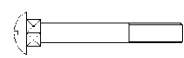
If parts are missing, please contact customer service: 203-591-9032. Missing parts will be sent courier to you. Do not return this product to the store!

PARTS LIST

Part #	Description	Drawing	Qty.
1	Upright Pole with Dimples		14
2	Upright Tube – Male Swedge		4
3	Bent Corner Leg		4
4	Common Tube – Male Swedge		28
5	Cross Rail with Dimples		18
6	Rafter Pole		14

7	Cross Rail – Male Swedge		12
8	Cross Rail with Punched Hole		12
9	3-Way Side Connector - Left		2
10	3-Way Side Connector - Right		2
11	4-Way Side Connector		10
12	3-Way Peak Connector		2
13	4-Way Peak Connector		5
14	4-Way Cover Rail Clamp		20
15	3-Way Cover Rail Clamp		8
16	Removable 15" Auger Anchor		4
17	Steel Foot Plate		10
18	M6 Nut		48+2
19	M6 X 45 Bolt		48
20	M6 Washer		24
21	Roof Cover # 9913770		1
22	Front Door Panel (with Zipper) # 2213770		1
23	Back Panel # 2413770		1

24	Wire Cable 1'		4
25	Cable Clamp		4
#	Owner's Manual		1

"#" Indicates a non-numbered part

Diagram A below represents the completed Frame Assembly once steps 1- 4 are completed.

Note: 2 or more people are required for safe and accurate assembly.

Step 1 – Collect your Tools

Tools required to assemble the shelter include:

- Safety Glasses – 1-pair per participant
- 1-Adjustable wrench or M6 box wrench
- 1-Rubber mallet (to be used to ensure all pipes are fully inserted)
- 1-Step stool or ladder – shelter is 8' tall
- 1-Hammer to set bolts

Diagram A

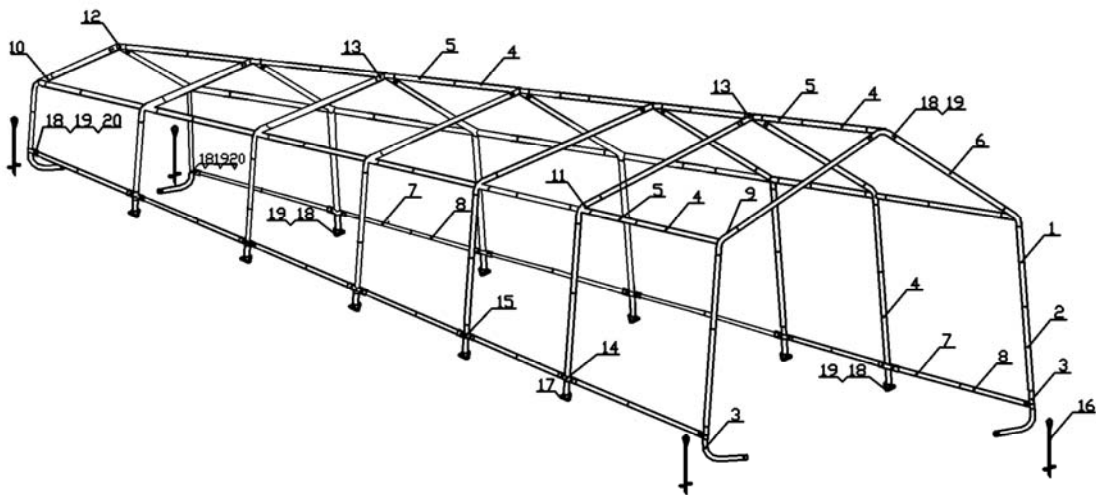

Step 2: Preparing the Roof Parts

Layout the roof parts as shown in **Diagram B**.

Assembly Tip: Pipes #5 are manufactured with square dimples on one end to act as pressure points. Ensure the end of #5 with dimples fits to male connector of pipe #4.

Diagram B

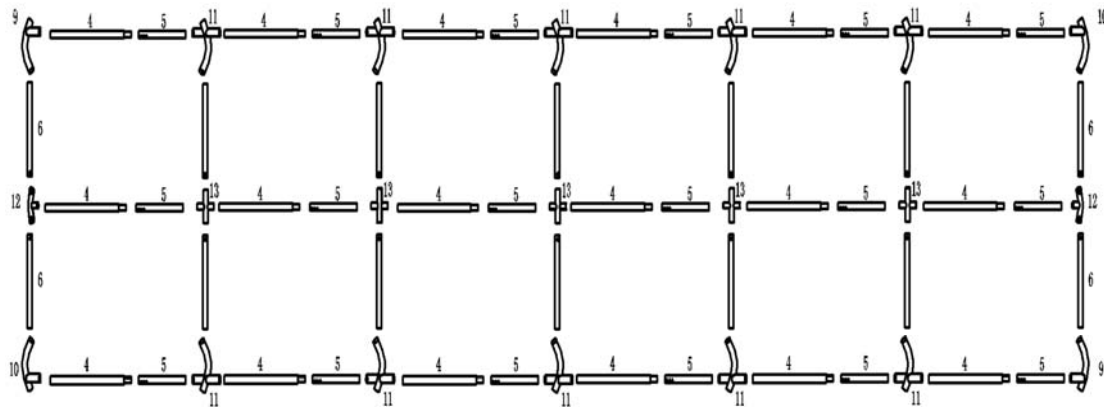

Assembly Tip: Pipes #6 are fitted with large holes to one end. Holes are to face toward the center or peak of the structure.

Assembly Tip: Connectors are fitted with plastic caps to prevent debris from entering pipes during assembly. Some types of debris may cause rapid development of rust. Keep plastic caps on parts until you are ready to connect that part to another part.

Please pay attention to the differences to the five connectors with reference to Diagram C below (connectors are also individually numbered).

Diagram C

Note:

1. When installed the welded socket for the cross rail must be below the bend.
2. Parts #9, #10 & #11 are Side Bend Connectors with Sharp Bend.
3. Parts #12 & #13 are Top Bend Connectors with sloping bend.

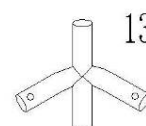
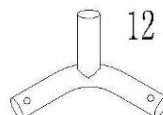
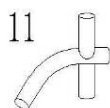
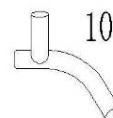
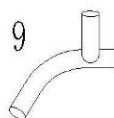
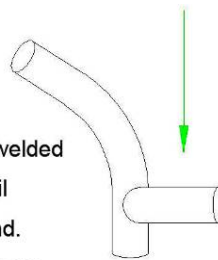

Step 3: Assembling the Roof

Connect all parts as shown in **Diagram D** to form the peak of the shelter frame. Use bolts #17 and nuts #18 to assemble the roof together. Install all carriage bolts with nuts facing into or toward the center of the frame.

Assembly Tip: Using a hammer, tap the bolts to wedge them slightly into the opening. When tightening the self-locking nuts, ensure to draw the bolt heads into the holes of the pipe so that the head of the bolt when fully tightened is flush with the pipe. Failure to do so may cause bolts to tear the shelter's cover.

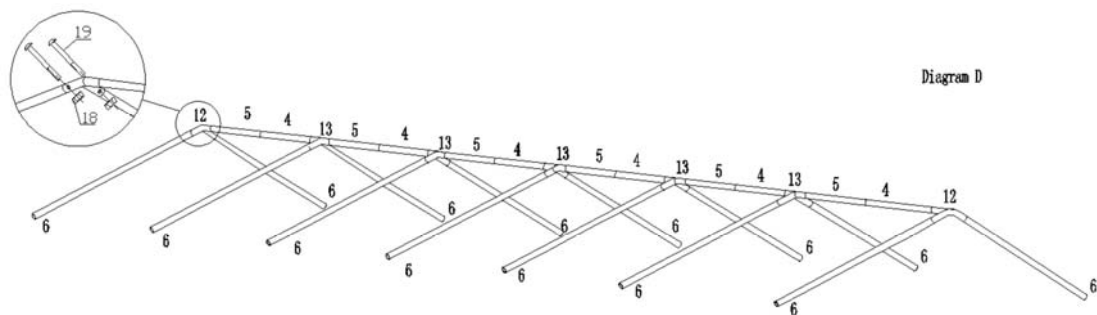

Assemble each side (shoulder) of the roof as shown in **Diagram E**.

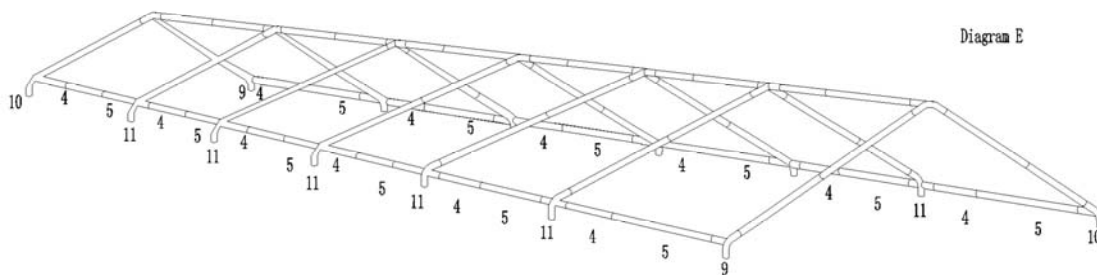

Use a rubber or wooden mallet to ensure all pipes are fully inserted.

Step 4: Attaching the Legs

a. Assemble the six legs: There are four corner legs and two center legs. Please refer to **Diagram F**. The corner legs are assembled by combining parts #1, #2 & #3. The center legs are formed by connecting parts #1 & #4.

Assembly Tip: Square dimples in pipes #1 and #2 are to face downward to provide a pressure fit with the next pipe.

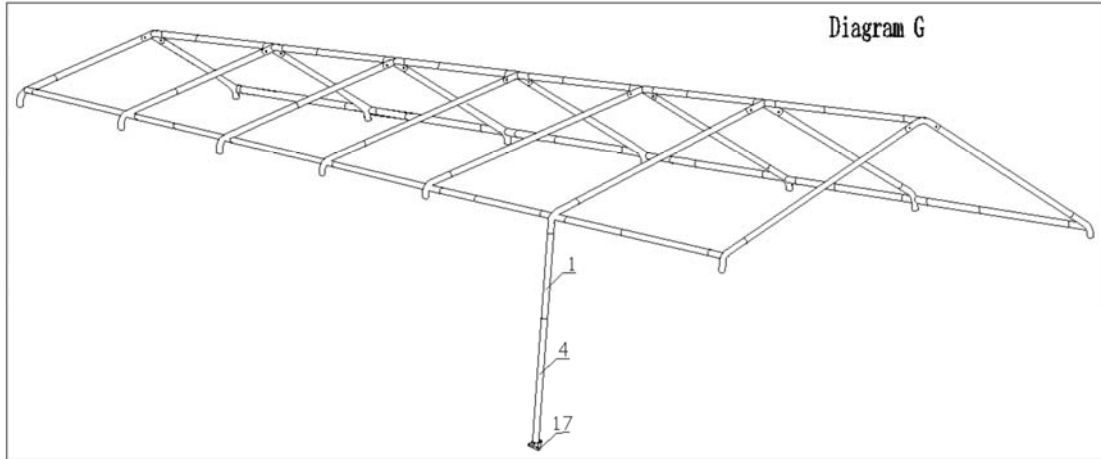
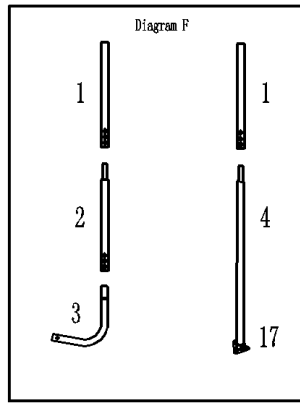

- b. Once legs are assembled, start from one side and insert middle leg pole first as shown in **Diagram G**. This is accomplished by one person lifting the side of the shelter while the opposite remains resting on the ground. A second person inserts the middle leg. Next, insert the corner leg assemblies as shown in **Diagram H**.
- c. Repeat for the other side as shown in **Diagram I**.

Note: No bolts are required for the assembly of the legs to the roofing frame.

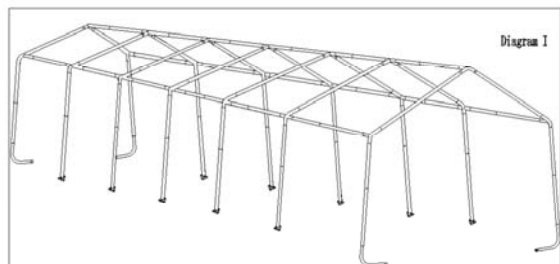
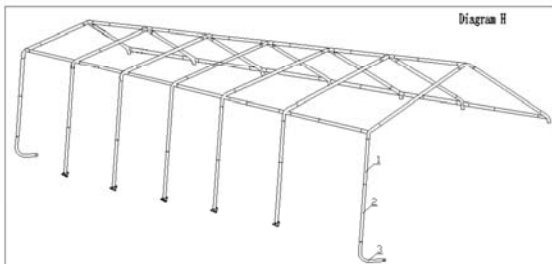

Step 5. Installing the Covers

Using the Ropes for roof tarp assembly.

Layout the Roof Tarp, make sure the pockets with black straps should be positioned so they will be located at the shelter front and back ends when assembly is completed. Also locate the open, empty pockets running perpendicular to the straps pockets and near two edges of the roof tarp. When the roof tarp is in position these empty pockets should be aligned facing the interior of the shelter along the

lower frame of both long sides.

Tie the two Ropes to the Roof Tarp through the eyelets on two corners. Throw the rope over the frame to the other side. Go to the other side and pull the rope to get the Roof Cover onto the frame. Draw the tarp gently over the frame ensuring that it does not snag.

Require two people to pull the rope together.

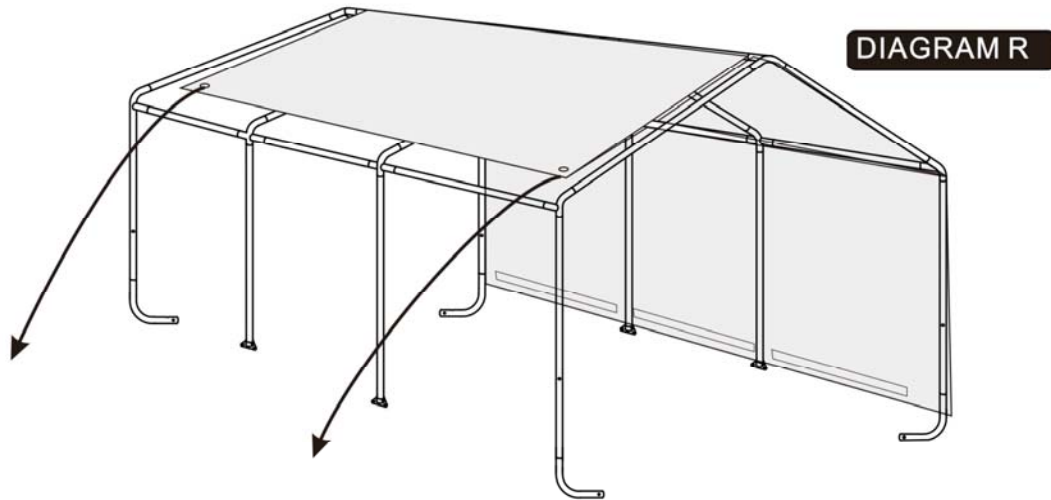

Once the roof tarp is draped over the frame check the overhang of the roof tarp at both the back and door panel. Ensure the overhang is approximately equal at each of the ends. If it needs to be adjusted both people pulling together from the same end of the structure to adjust the estimated amount simultaneously or the roof tarp may become twisted.

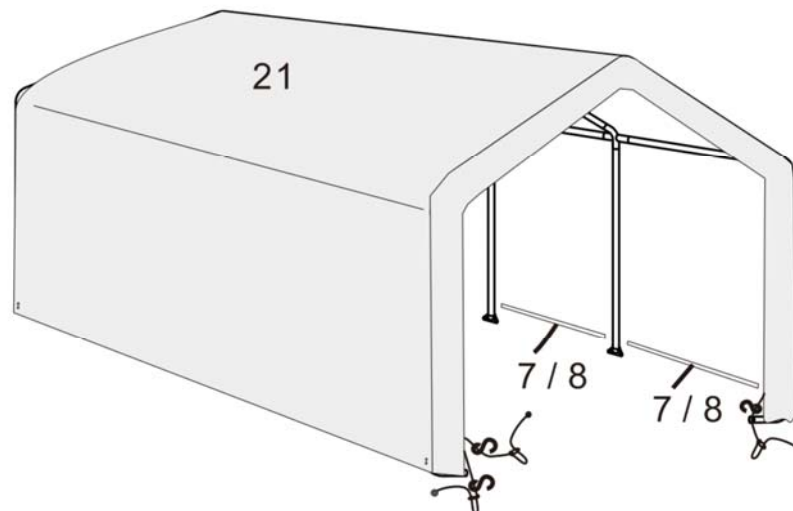

Starting from the peak, remove the Cross Rail from the 3-way top connector. Place exposed Rope at the top of the panel over the 3-way connector and under the cross pole as shown in Detail E next page. Replace the cross Rail. At each corner remove the Cross Rail and pull the fabric around to the inside, placing the 3-way socket through the opening in the fabric as shown in Detail D. Tighten the panel by inserting "S" hooks into the holes in the corner legs, pulling and tying off as shown in picture 3. Repeat above for another door.

DIAGRAM L

Installing doors

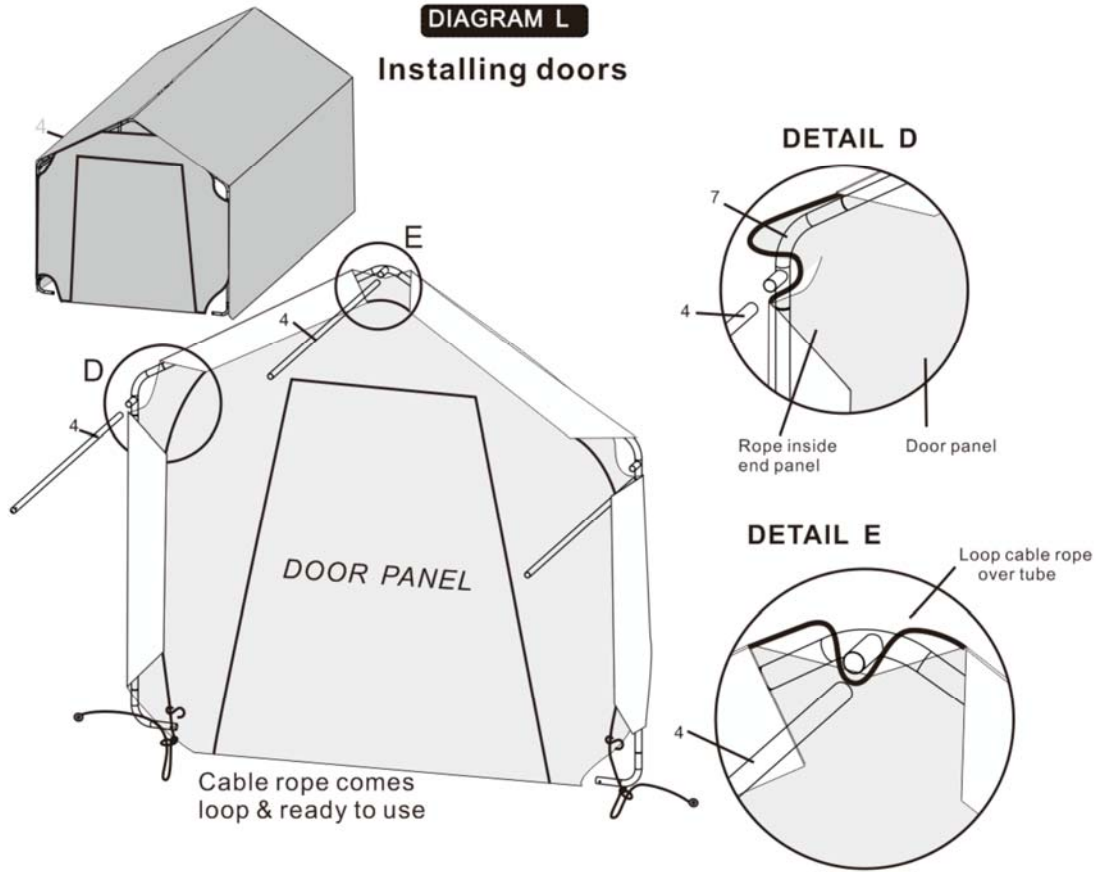
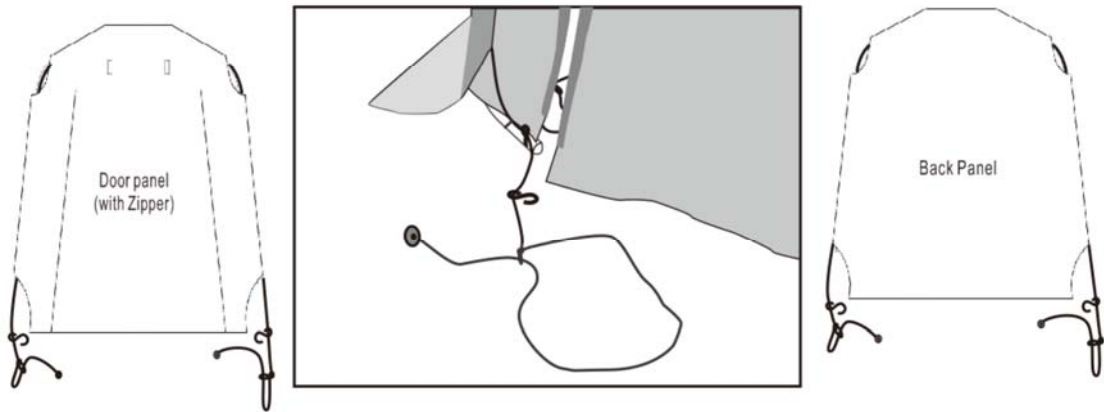
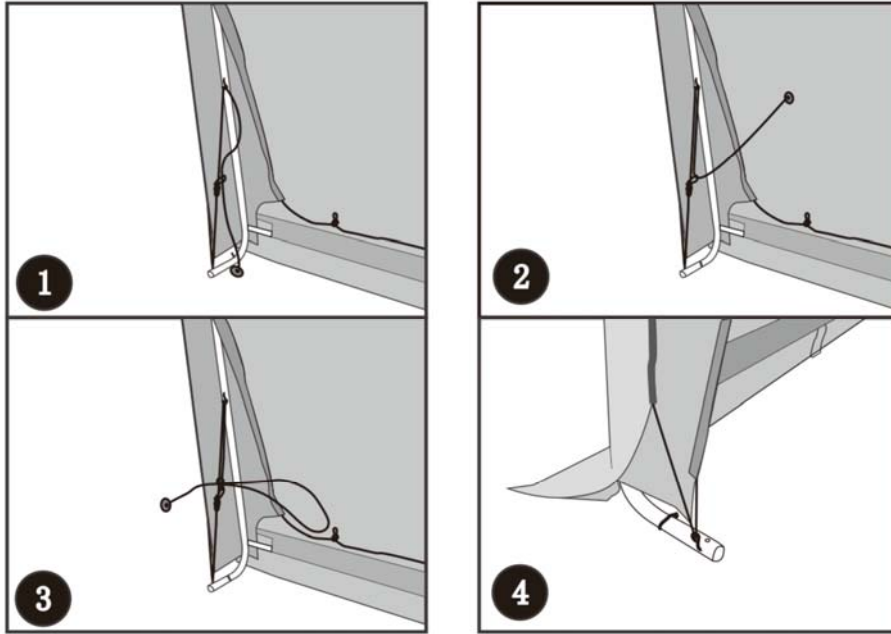
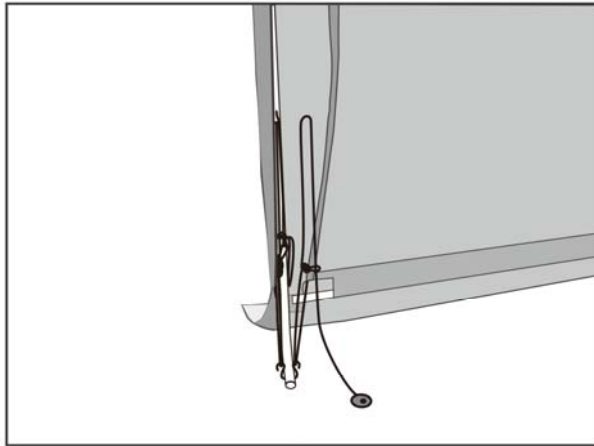

DIAGRAM L





The left picture shows what it looks like after the End panel is tightened.



Tighten the roof tarp to Corner Bent leg. Punch a small hole to allow the rope from bottom of roof tarp go thru. Repeat the same process for End panel, tighten the roof panel from inside.

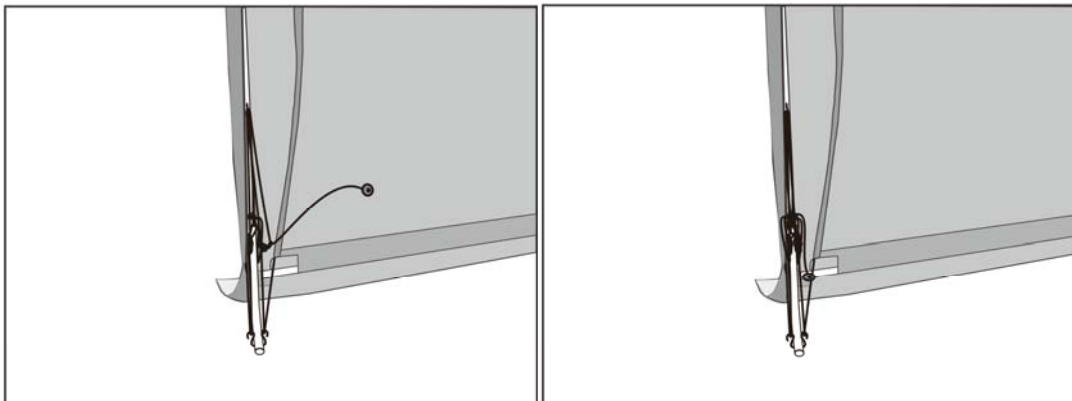

Once satisfied with the placement insert the remaining Cross Rail through the interior pockets of the roof tarp.

Step 6: Square and Anchor the Shelter

- a) Ensure the frame is in the final desired location.
- b) Check the measurement of 12' at the front corners, back corners and the center.
- c) Take a diagonal measurement, cross-corner to cross-corner (A to B and C to D) as shown in **Diagram L**. When these two measurements are equal the shelter is square. If not equal, tap the corner leg of the longer measurement with the rubber mallet, in the direction of the diagonally opposite leg to push (decrease) the length of the distance. Repeat (always taping against the longer measure) until both diagonals are equal.
- d) Once equal, check the width measurements again to ensure all are equal at 12'.
- e)

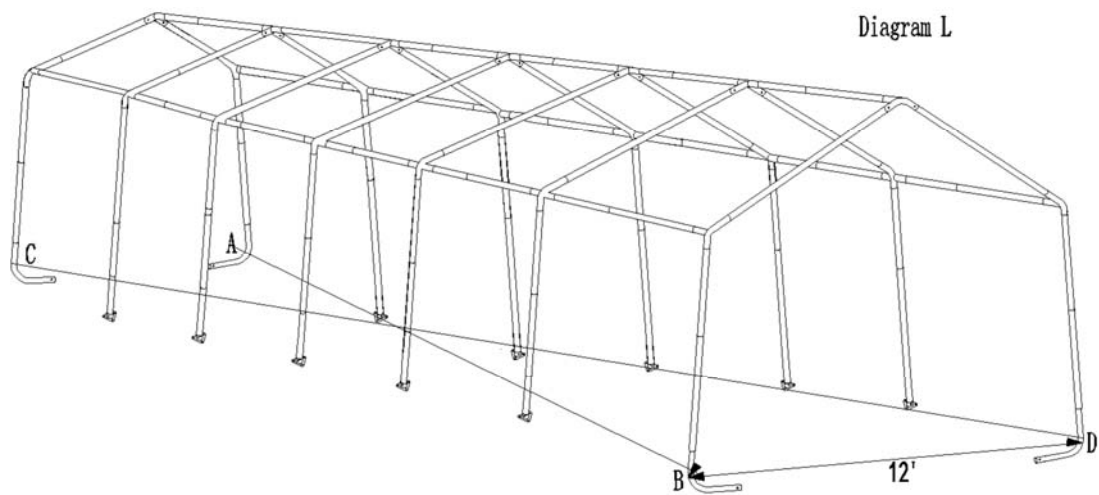

- f) Next, at the curved feet of the shelter install anchors, by screwing the Removable Anchor #16 into the ground and to the inside of the shelter.
- g) Secure with Cable #25 and Cable Clamp #26 as shown in **Diagram M** below.

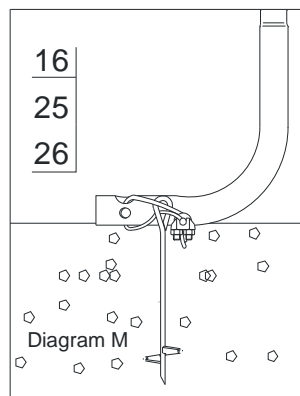

Step 7: Installing Lower Cross Rails

The shelter cover is manufactured with heat-welded pipe pocket sleeves along the lower wall of each side (white color faces to the interior, colored side to the exterior).

- a) Assemble Cross Rails #7 and #8 into four pairs (two pairs per side – **Diagram J** depicts pipes in final position AFTER the cover has been installed and utilizing cover brackets step-d).

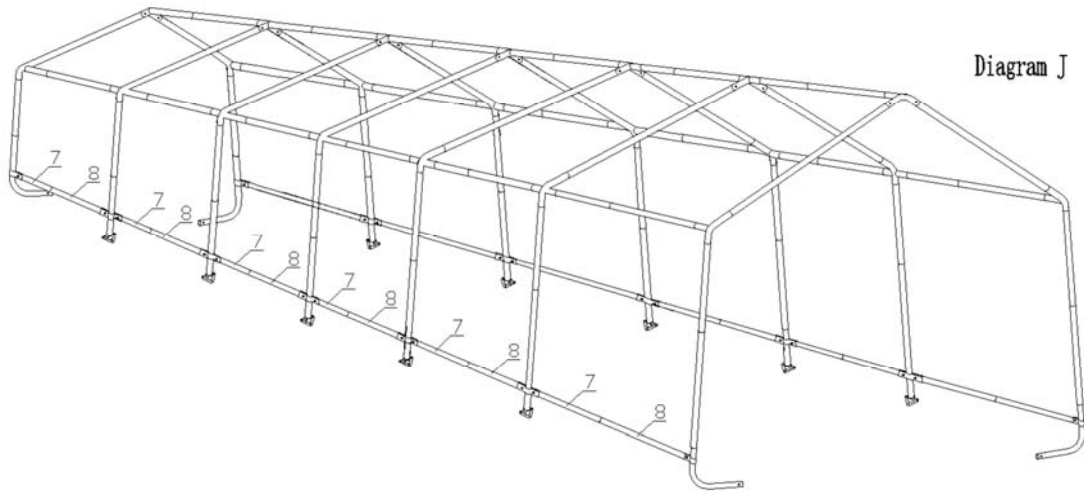
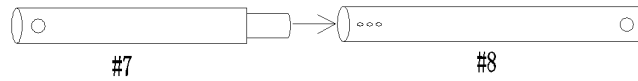

b) Insert one pair of cover rails to each sleeve along one side of the cover (see below image).

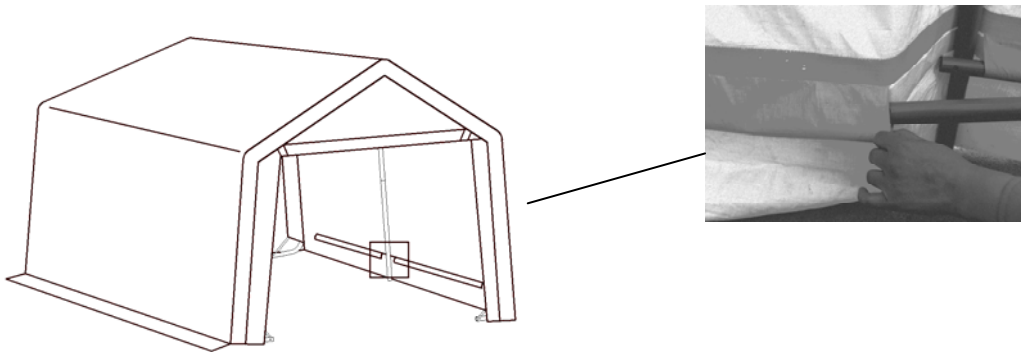

c) Install Cover Rail Clamps parts #14 & #15 as shown in **Diagram K**. Part #14 is for middle legs, and #15 for corner legs. Slide the cross rails until they are 10" up from the ground and *loosely* tighten bolts. To install, wedge bolt into hole by taping with a hammer prior to tightening the self-locking nut. NOTE: be sure to face bolts / nuts to the interior side of the shelter to avoid tearing the polyethylene cover.

Diagram k

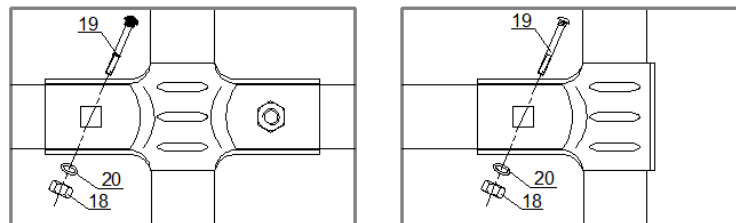

For middle legs

For corner legs

d) Once the rail clamps and pipes of the lower rail have been installed to one side, you are ready to pull the cover over the frame and to the other side of the shelter.

Installation Tip: Visually check all pipes of the frame to ensure they are fully inserted into the next pipe before installing cover. Pipes may separate during installation of end covers and prevent proper installation of the main cover

- e) Two people, each positioned approximately one-third into the center of the cover, carefully pull the cover over the frame. When reaching the peak use a step stool or ladder to pass over this height.
- f) Once the cover is properly positioned, i.e. equally overlapping both the front and back end covers of the shelter, repeat the bottom rail steps of points b), c) and d) above, to the loose side of the cover.
- g) Ensuring that the lower cross rails of both sides of the shelter are approximately equal height from the ground, and holding the cover taut in its location, tighten the bolts of the rail clamps. NOTE: push down on cross rails to tighten cover before tightening bolts completely.

**PLEASE RE-READ ALL WARNINGS CONTAINED ON PAGE 3 OF THESE INSTRUCTIONS.
SAVE THESE INSTRUCTIONS FOR FUTURE USE.**

To dismantle, execute all instructions in reverse order.

Store your shelter in a cool, dry location between seasons to prolong usable life of all components.

Components are not equally durable and will require replacement over time at differing intervals.

PRODUCT DIAGRAM

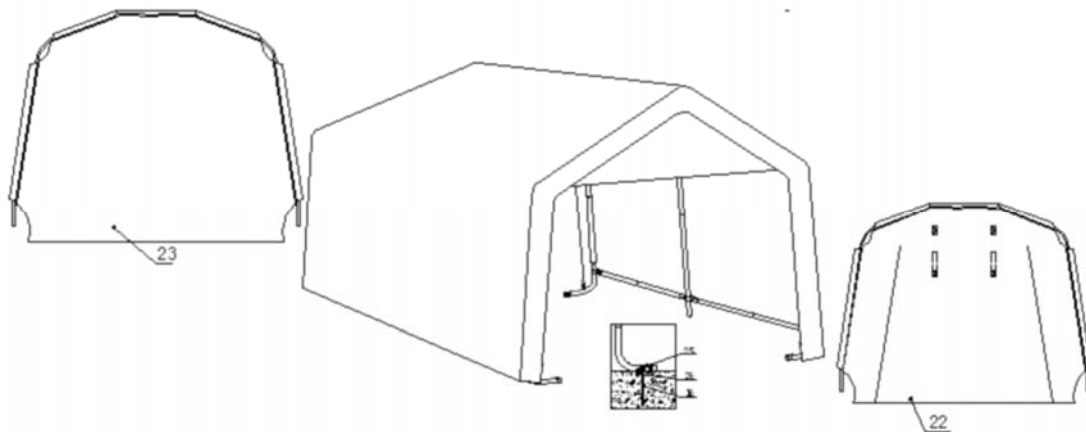

LIMITED WARRANTY

This product is guaranteed for **1 year from the date of original retail purchase** against defects in materials and workmanship.

Subject to the conditions and limitations described below, this product, must be returned with proof of purchase within the stated warranty period and if covered under this warranty, will be replaced (fully or partially with the same model or one of equal value or specification) at the Manufacturer's option. Liability is restricted to repair or replacement only and does not include any related labor costs of installation, dismantling, repair or transportation costs.

These warranties are subject to the following conditions and limitations:

- a) A bill of sale verifying the purchase and purchase date must be provided.
- b) This warranty will not apply to any product or part thereof which is worn, broken or which has become inoperative due to abuse, misuse, accidental damage, neglect or lack of proper installation, operation or maintenance (as outlined in the applicable owner's manual or operating instructions) or which is being used for industrial, professional, commercial or rental purposes.

- c) This warranty will not apply to normal wear and tear or to expendable parts or accessories that may be supplied with the product which are expected to become inoperative or unusable after a reasonable period of use.
- d) This warranty will not apply to routine maintenance and consumable items such as the cover, ratchets, webbed belts, nuts, bolts, etc.
- e) This warranty will not apply where damage is caused by repairs made or attempted by others (i.e. persons not authorized by the manufacturer).
- f) This warranty will not apply to any product that was sold to the original purchaser as a reconditioned or refurbished product (unless otherwise specified in writing).
- g) This warranty will not apply to any product or part thereof if any part from another manufacturer is installed therein or any repairs or alterations have been made or attempted by unauthorized persons.
- h) This warranty will not apply to normal deterioration of the exterior finish, such as, but not limited to, scratches, dents, paint chips, or to any corrosion or discolouring by heat, cold, abrasive and chemical cleaners.
- i) This warranty will not apply to component parts sold by and identified as the product of another company, which shall be covered under the other product manufacturer's warranty, if any.

Additional Limitations

This warranty applies only to the original purchaser and may not be transferred. Neither the retailer nor the manufacturer shall be liable for any other expense, loss or damage, including, without limitation, any indirect, incidental, consequential or exemplary damages arising in connection with the sale, use or inability to use this product.

Notice to Consumer

This warranty gives you specific legal rights, and you may have other rights, which may vary from province to province. The provisions contained in this warranty are not intended to limit, modify, take away from, disclaim or exclude any statutory warranties set forth in any applicable provincial or federal legislation.